

AIJ-42 TYPICAL INSTALLATION

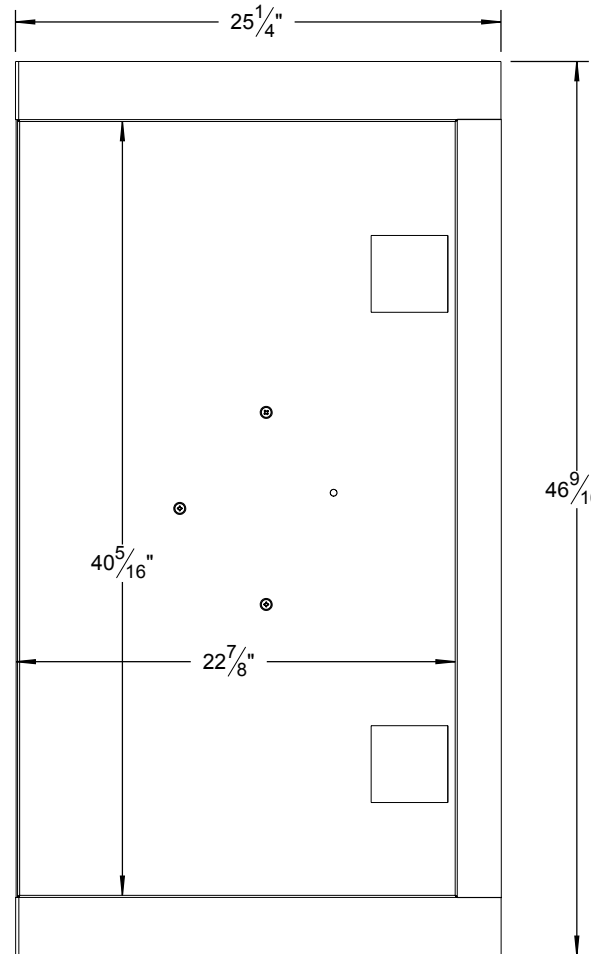

COUNTER CUTOUT REQUIREMENTS

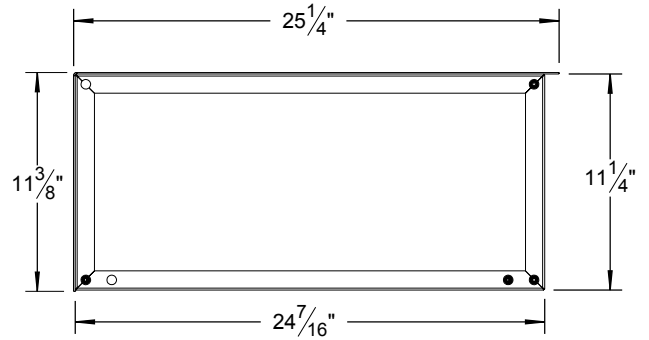
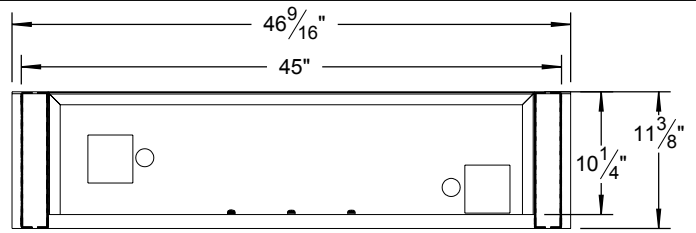
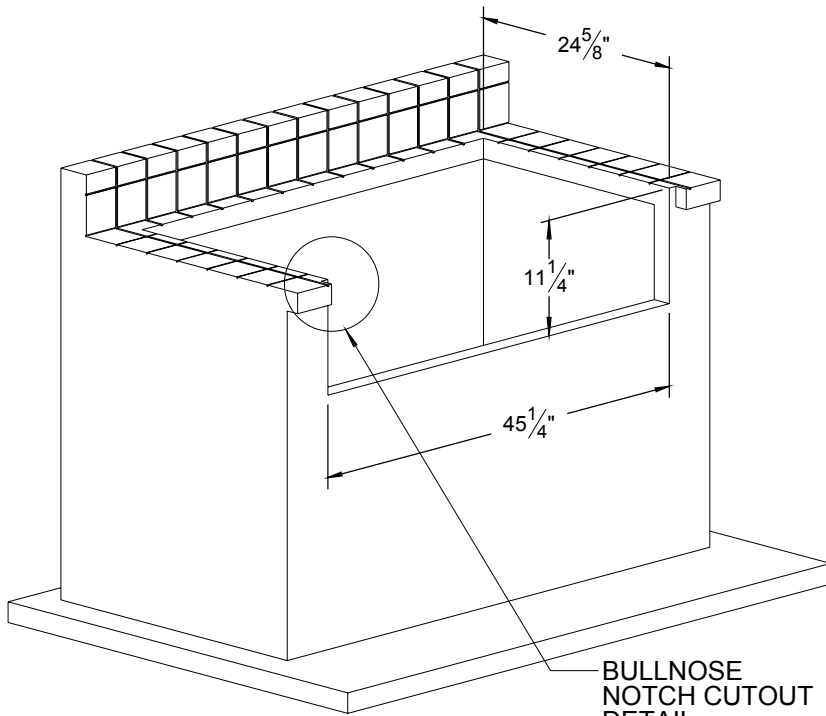

BULLNOSE NOTCH CUTOUT DETAIL

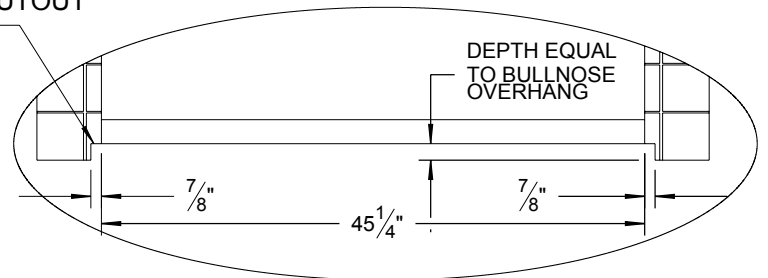

NOTE:

COUNTER MUST HAVE THE PROPER ELECTRICAL AND GAS SUPPLY FOR YOUR BARBEQUE MODEL. REFER TO YOUR BARBEQUE UNIT'S MANUAL AND SERIAL PLATE INFORMATION FOR INFORMATION.